

Fire Rated Plasterboard 13mm strip x 120mm wide fixed to the KOROK® C-track with pairs of 6g x 22mm screw fixings at 250mm centres. Screw location in line with the 250mm vertical KOROK® panel joints

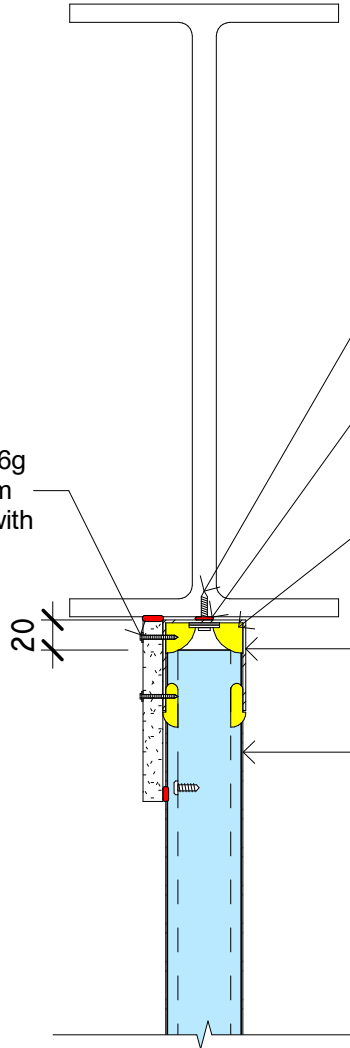

Where the fire rated junction is included in a fire separation wall, refer to the fire protection designer for the FRR of the wall

Fixings @ 400mm centres into the supporting structure

Fire Rated Sealant laid in with caulking gun as specified

Sealant config - All red and minimum 2 x yellow for each C-Track

KOROK® C-track 60 x 51 x 60 x 1.15 BMT

KOROK® 51mm panels laid in vertical orientation

Fire Rated Plasterboard 13mm Strip x 120mm wide fixed to the KOROK® Top track with pairs of 6g x 22mm screw fixings at 250mm centres. Screw location in line with the 250mm vertical KOROK® panel joints

KOROK® C-track 60 x 80 x 60 1.15 BMT

Note: When omitting screws from the top C-track 10g x 16mm screw fixings are to be placed into the KOROK® panel joints, nominally 50mm below the KOROK® C-Track one side only

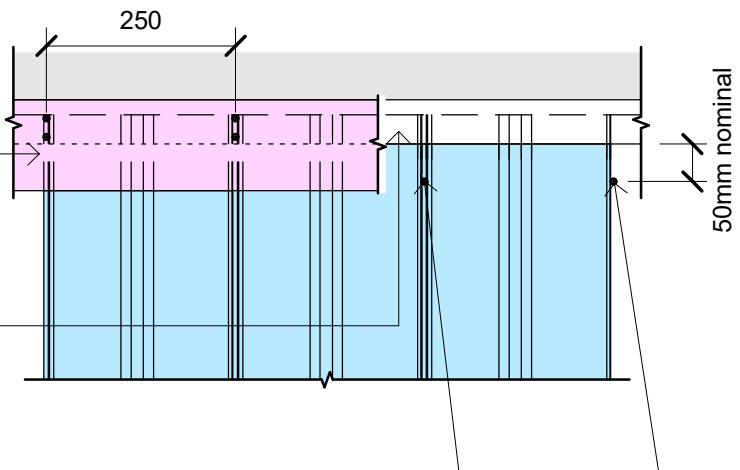

KOROK®

Deflection Head 20mm

KOROK® 51mm Panel deflection head detail FRR -/60/60

File: korok_deflect.rvt	Date: May 2023	Scale: As indicated
Issue: 23a		
Reference		

KOROK_KDF_51060_003

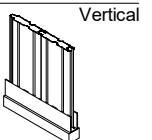

Vertical